

DWK DWT

ES INSTRUCCIONES DE INSTALACIÓN
Puerta de registro termoaislante para pared bajo buhardilla

FR INSTRUCTION D'INSTALLATION
Portillon de comble thermo-isolant

US INSTALLATION INSTRUCTIONS
Insulated Knee Wall Access Door

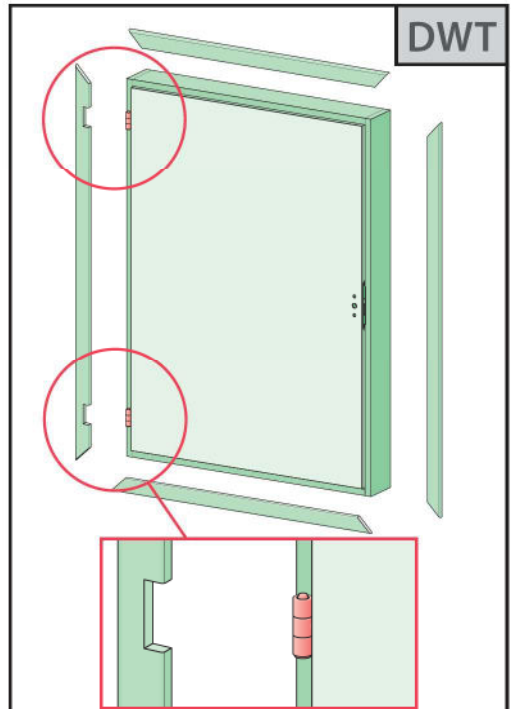
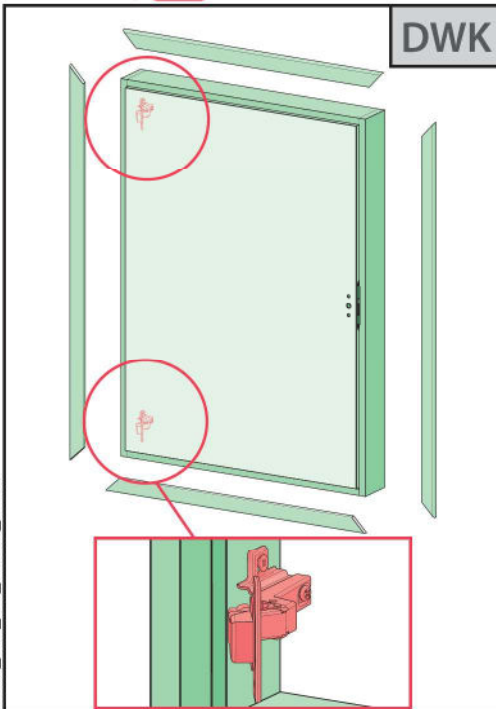
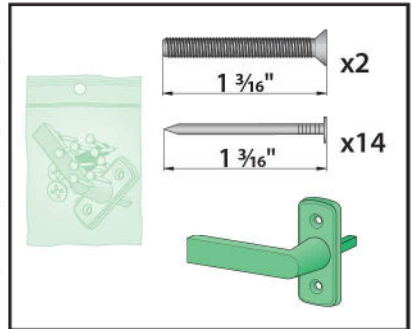

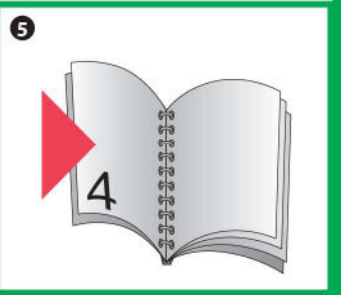
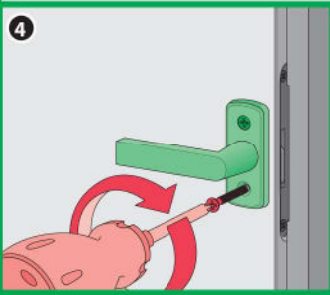
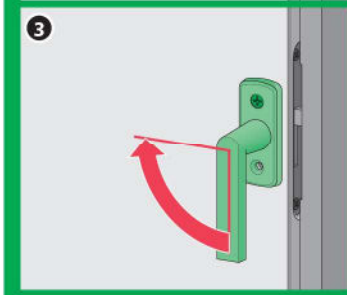
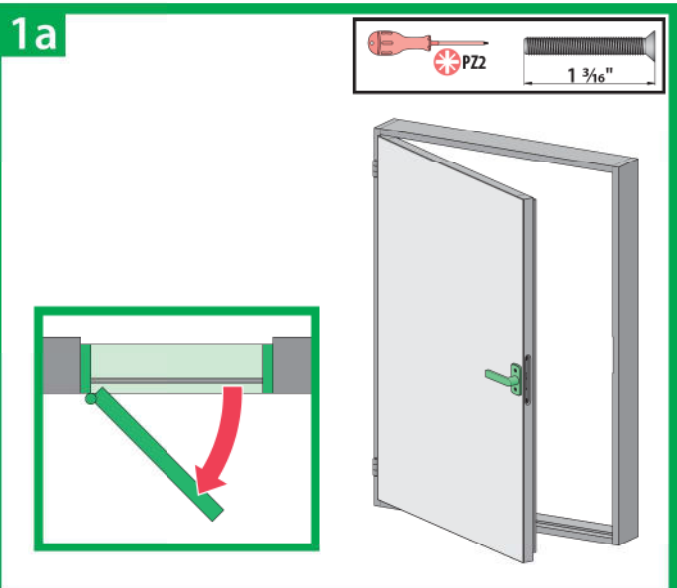
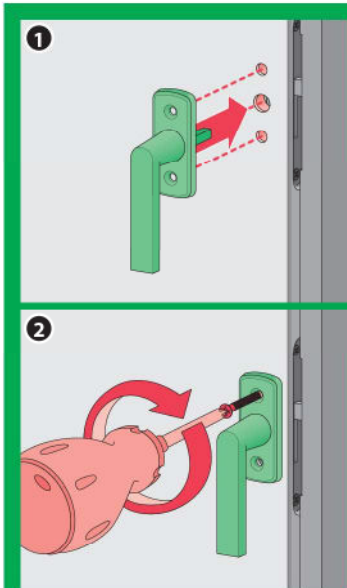
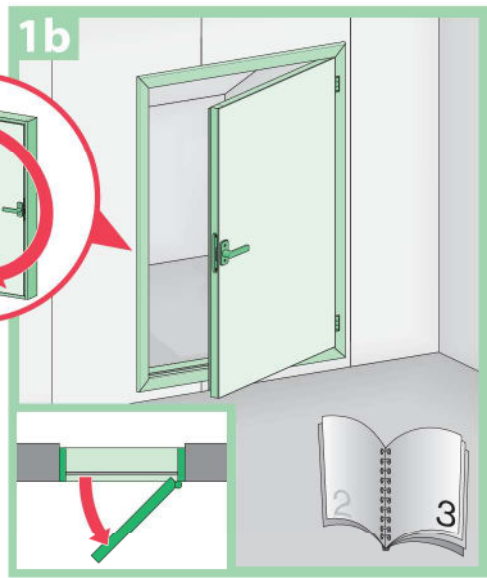

1b

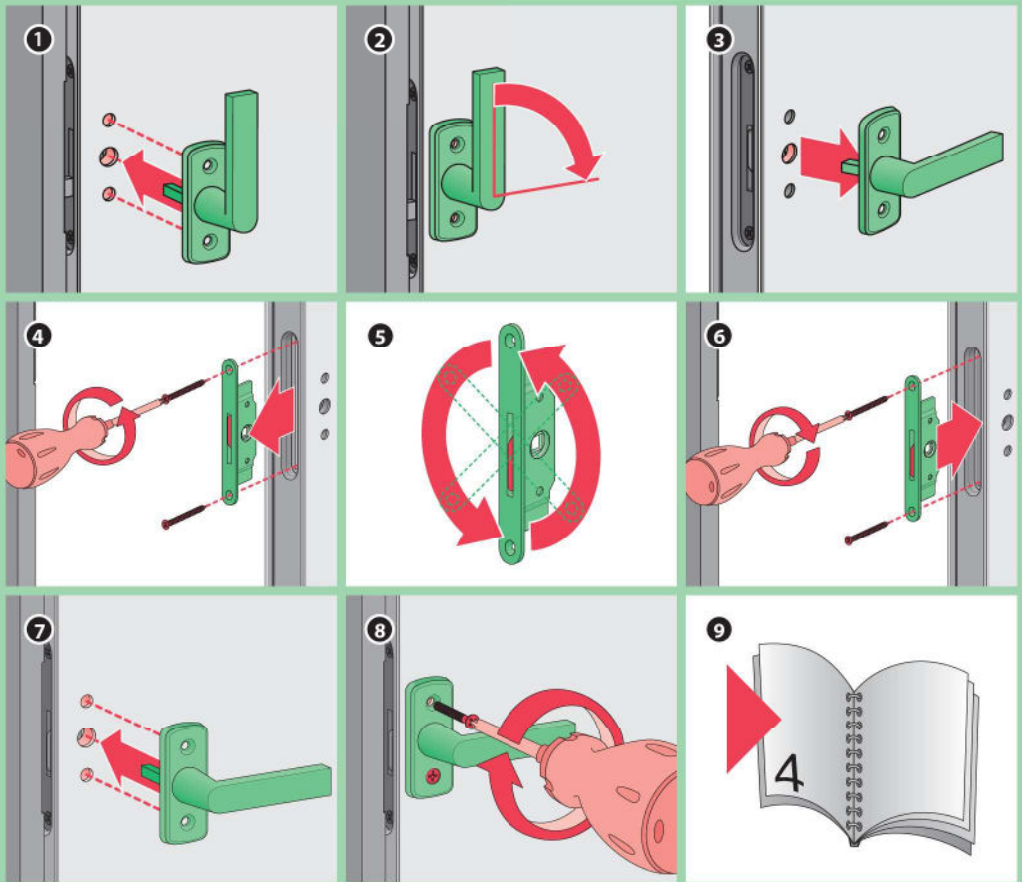
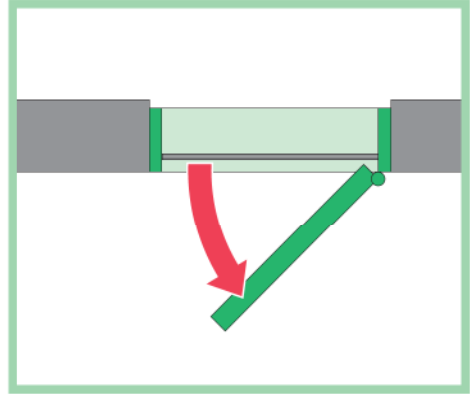
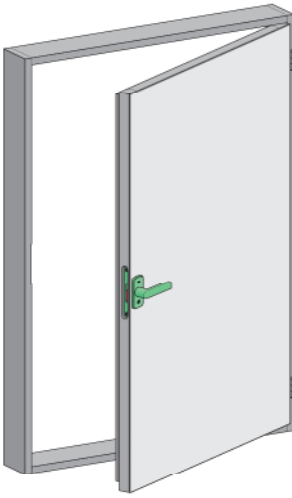

2

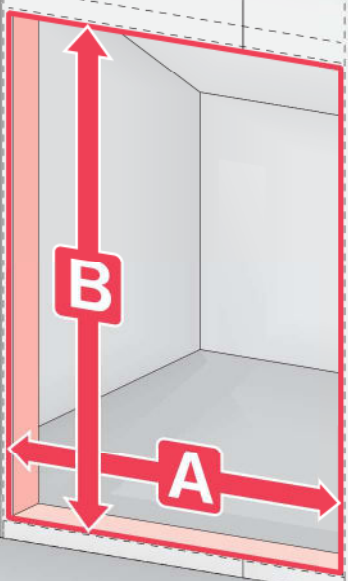

DW_

A" x B"

NR. ART.
869600
 Info: www.fakrousa.com
www.fakro.ca



 ~ lbs W = "
  ~ m³ L = "
 



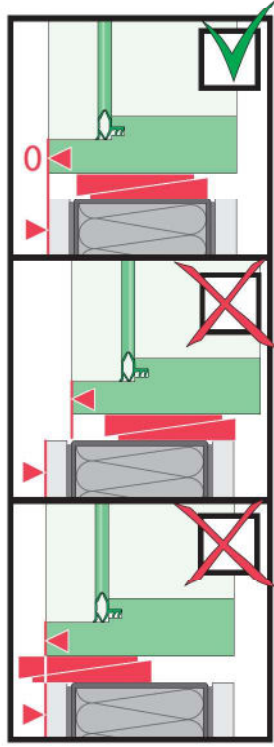
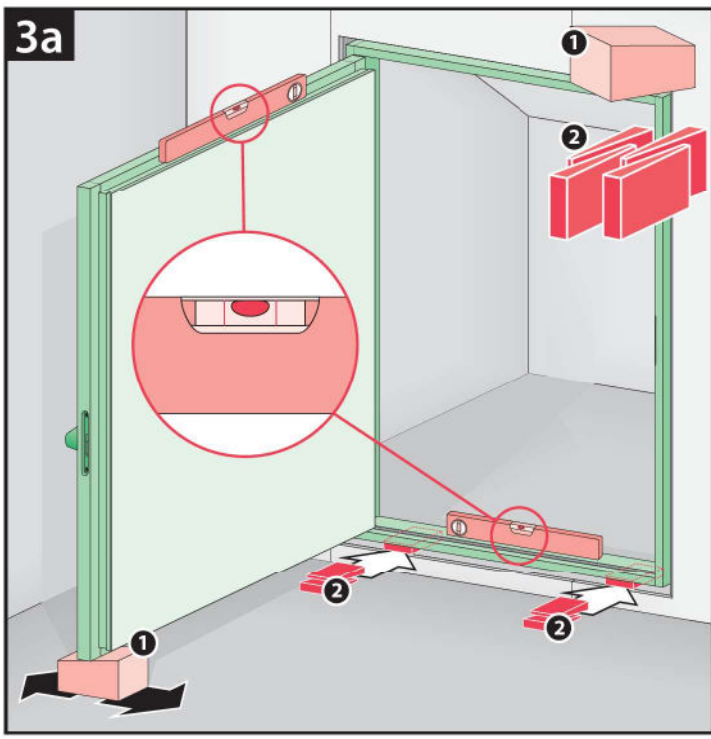

3a

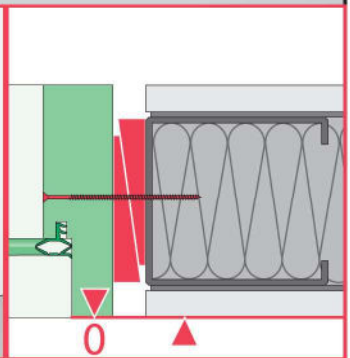
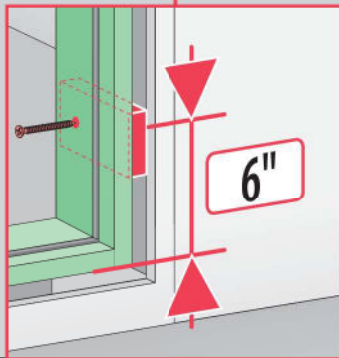
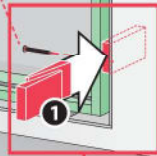
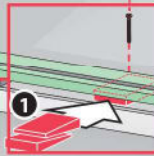
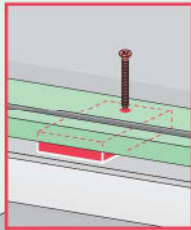
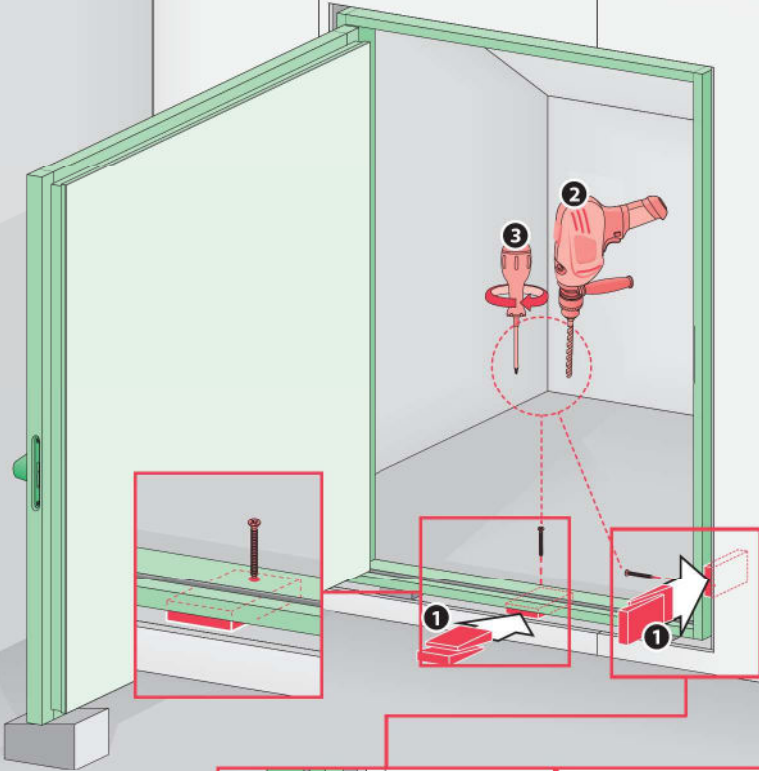
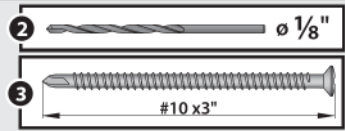

3b

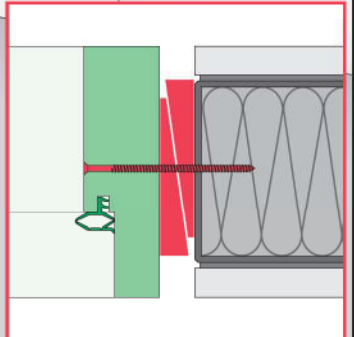
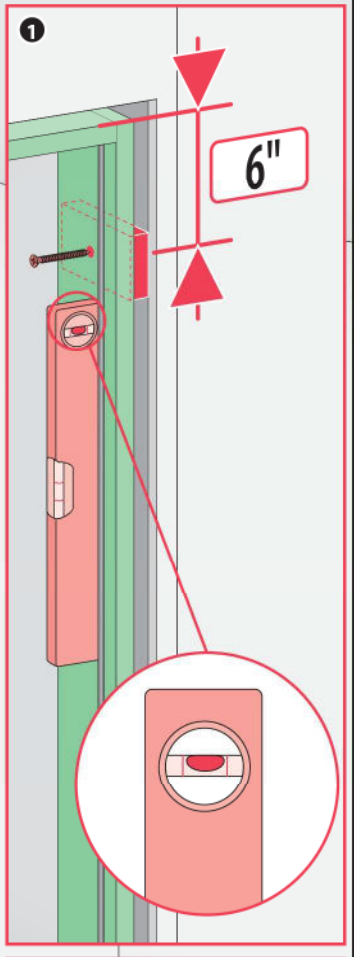
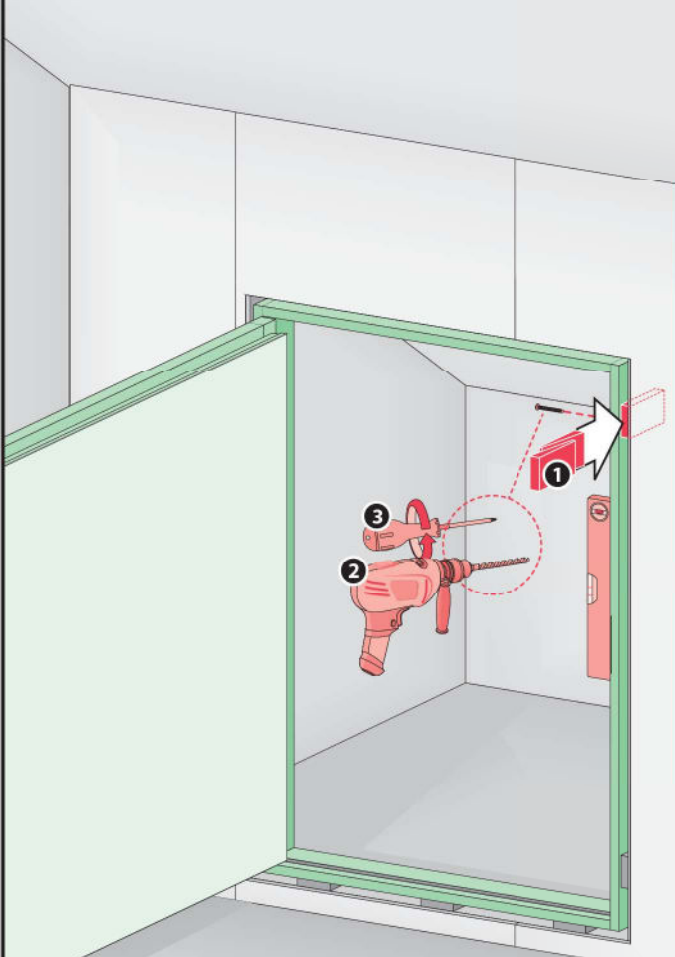
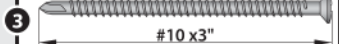

3c



4c

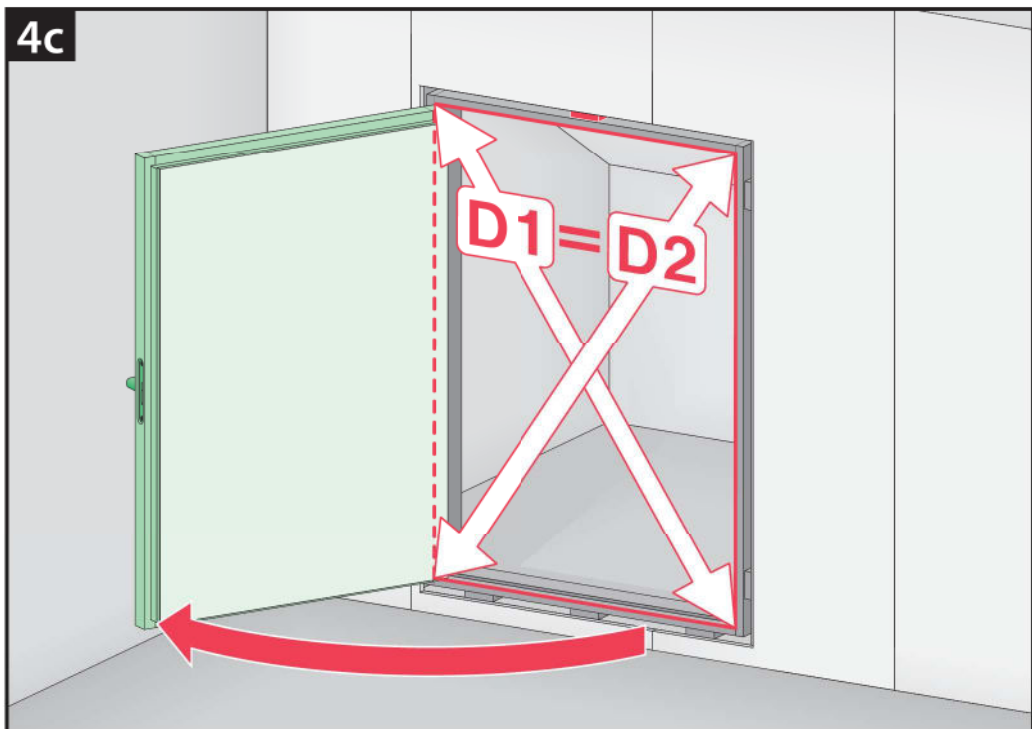

4d

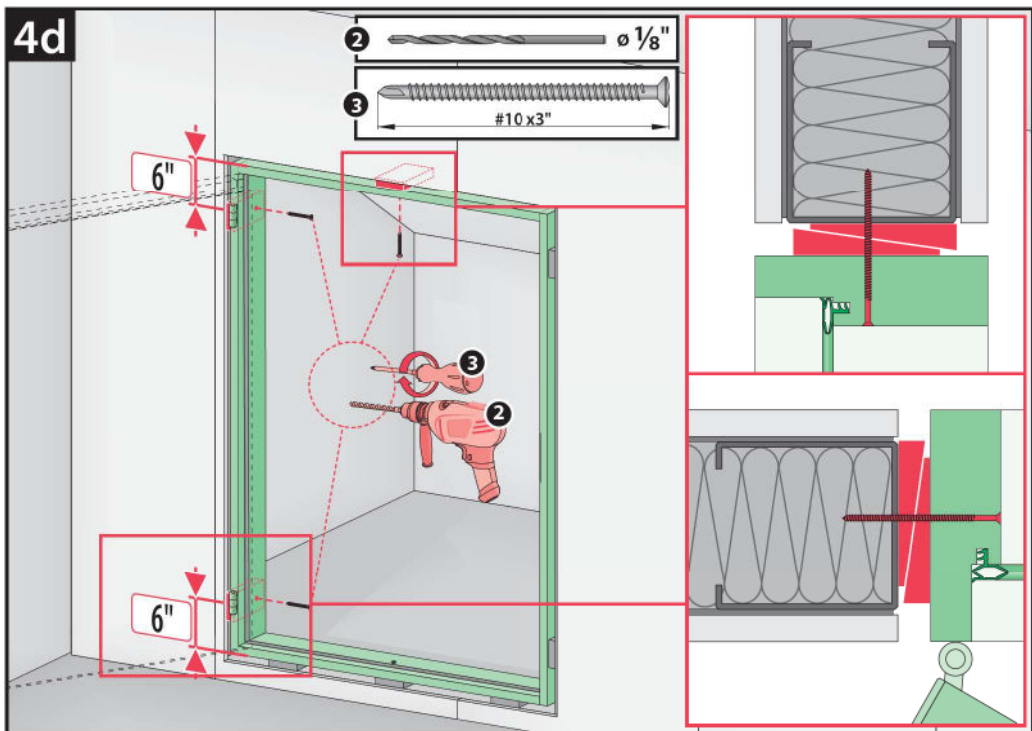

4e

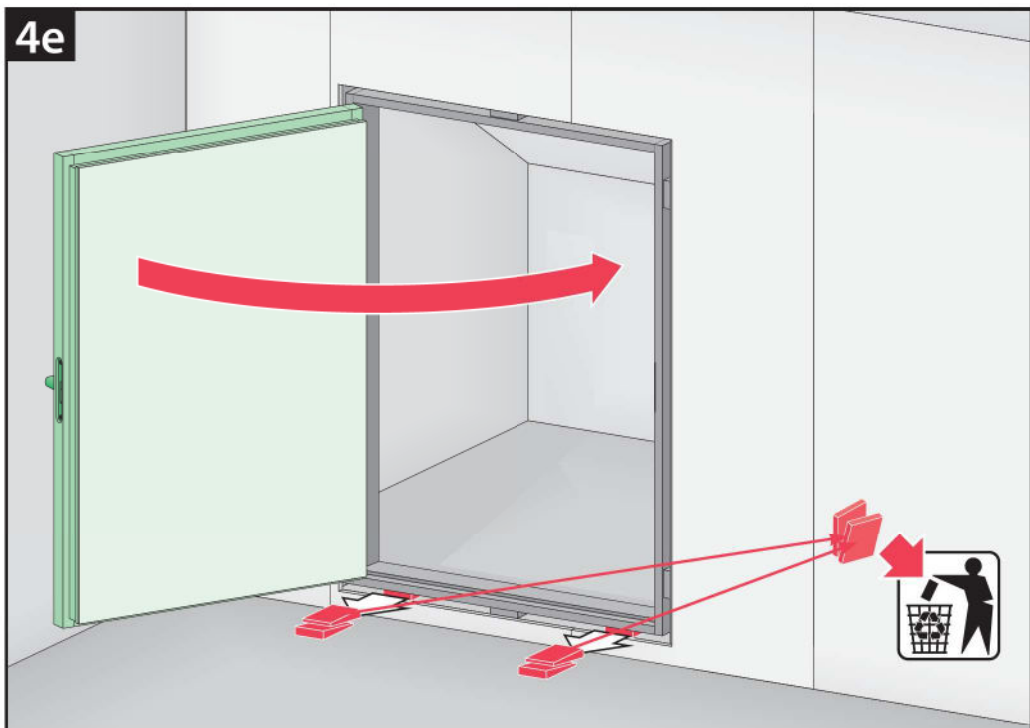

5

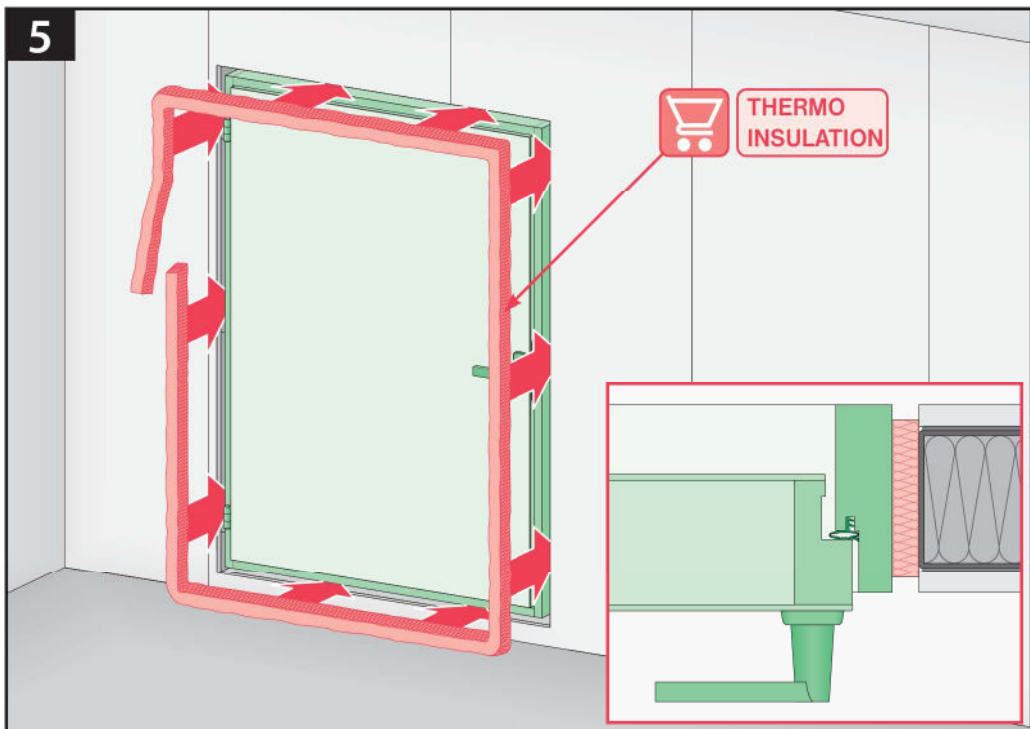

6

1 3/16"

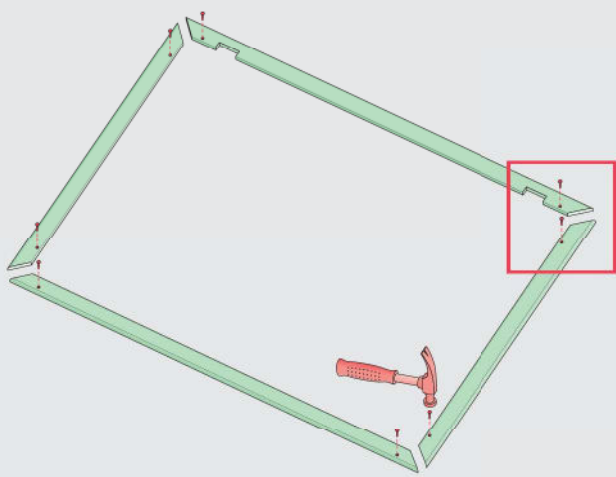
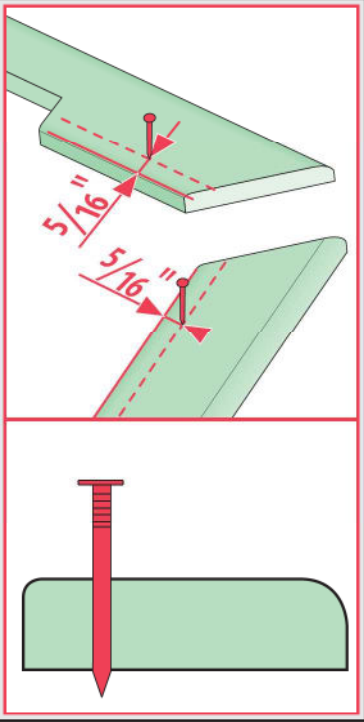

7a

1 3/16"

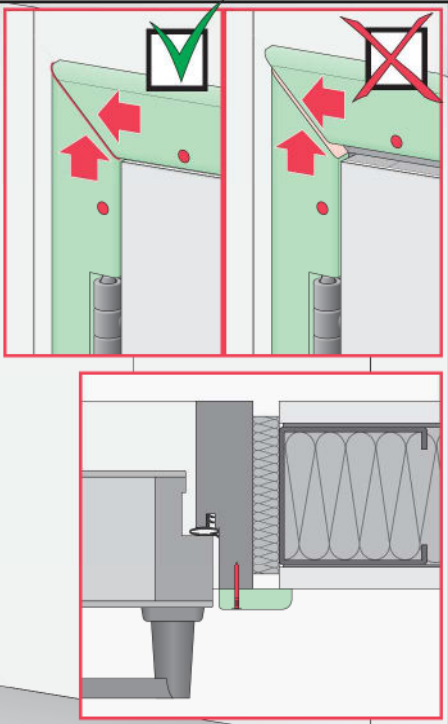

7b

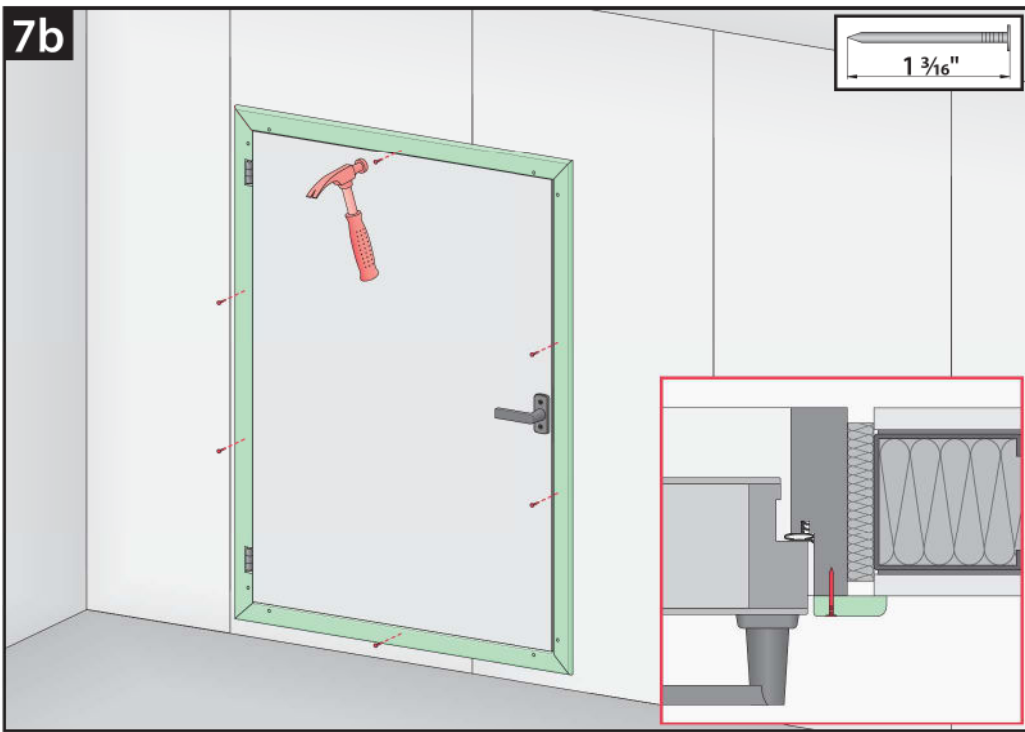
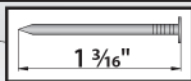

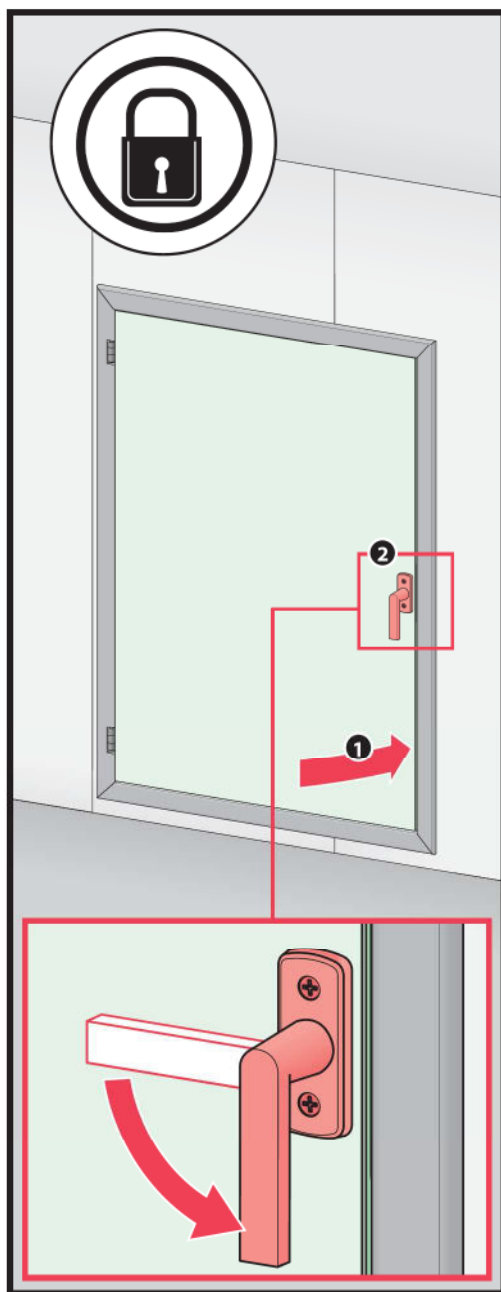
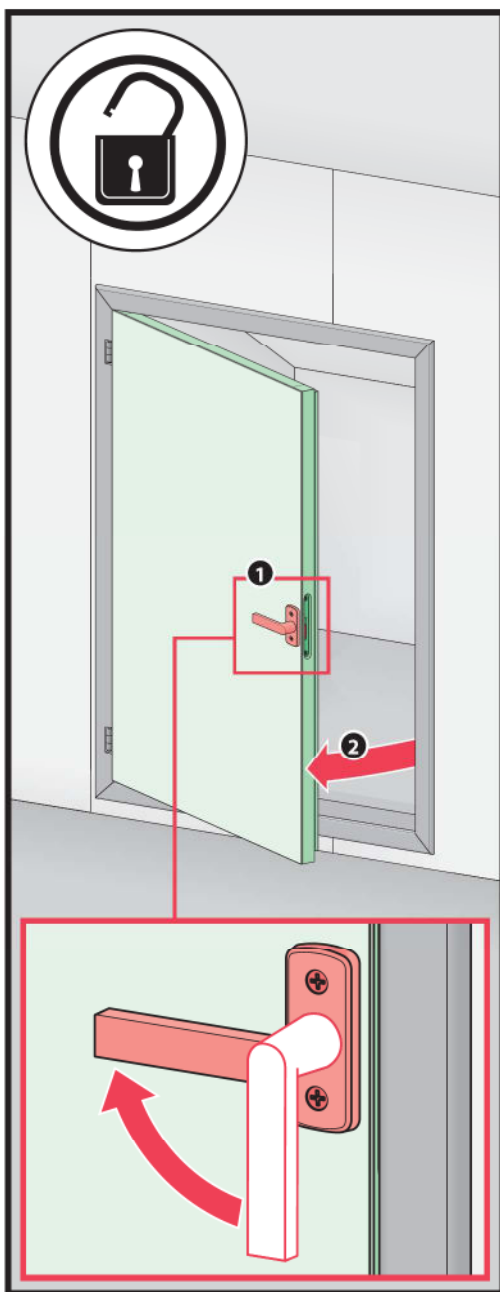

ES El fabricante y el vendedor no tienen ninguna responsabilidad por el incumplimiento de la ley vigente, normas de construcción y exigencias de seguridad por parte del usuario del producto, arquitecto, instalador o el propietario del edificio.

FR Le fabricant et le revendeur ne prend aucune responsabilité de ne pas respecter les lois applicables, les règlements sur les bâtiments et les exigences de sécurité par l'utilisateur du produit, l'architecte, l'installateur ou le propriétaire du bâtiment.

US Manufacturer and Seller shall bear no liability for failure to comply with the applicable laws, building codes and safety requirements by the user of the product, architect, fitter or owner of the building.