



# Product Data Sheet

## Ceiling Ducted ADK10R4H2

List:\$8,375

- Integrated ERV
- 1,800W electric heat
- R410a
- 230V



### **SAFETY WARNING**

Only qualified professionals should install and service this equipment. Improperly installed or modifications by an unqualified person could result in death or serious injury. When working on the equipment, observe all precautions in the installation manual and labels attached to the equipment.



# Contents

<b>Key Features</b>	<b>3</b>
<b>Technical requirements</b>	<b>4</b>
AIO Ceiling ducted specifications	4
Louver specifications	4
<b>What's inside</b>	<b>5</b>
<b>Technical specifications</b>	<b>6</b>
<b>Airflow</b>	<b>8</b>
<b>Understanding the ratings</b>	<b>9</b>
How AIO works	9
Heat Pump	9
Explanation of the terms	9
ERV	10
Combined Heat Pump + ERV Section	10
<b>ADK10R4H2 Submittal</b>	<b>11</b>
<b>Dimensions</b>	<b>12</b>
<b>Clearances</b>	<b>13</b>
<b>Wiring Diagram</b>	<b>14</b>

AIO Ceiling ducted can be discreetly installed above a ceiling and is ideal for single or multi-room applications. The return can be from the sides or the bottom for maximum flexibility. With up to 0.6" external static pressure, this unit can be used where ducting is required. Use with any interior grille and louver to provide additional design flexibility. A bathroom exhaust can connect to the dedicated stale air exhaust.

**Ephoca is constantly innovating and improving its products and reserves the right to modify product design and specifications without notice and without incurring any obligations.**

Ephoca is the US subsidiary of Innova SRL - Via 1° Maggio, 8 - 38089 Storo (TN) Italy.

© 2023 Ephoca. All rights reserved.

# Key Features

## ■ No outdoor unit

The single package design means no outdoor unit, freeing up space on rooftops and at ground level and enabling installations in buildings without space for an outdoor unit.

## ■ Twin rotary BLDC inverter compressor

The state-of-the-art twin rotary BLDC inverter compressor operates efficiently, quietly, and with minimal vibration. AIO is ideal for any room or area that requires between 4,000 and 10,500 BTU.

## ■ Integrated ERV

AIO's integrated ERV eliminates the requirement of installing an independent ERV system, ducting, electrical work, and engineering.

## ■ Recovery plus™

With a patent pending innovation, AIO utilizes the heat or cold remaining in the air after passing through the recovery core to lower or raise the temperature of the condenser, enabling a boost in performance and efficiency.

## ■ Integrated bathroom exhaust system

The integrated stale air exhaust can be used for bathrooms and kitchens, maintaining perfect air pressure and eliminating a dedicated exhaust system.

## ■ MERV 13 clean air

Clean outdoor air is essential to well-being and safety. The MERV 13 filter ensures that all air entering the room/home is clean and safe. Additionally, stale air is passed through a second MERV 13 filter keeping the core clean.

## ■ High-efficiency ECM fans with auto ESP

High-efficiency ECM fans enable efficient and quiet operation as the EC motor can ramp up or down depending on the need. Automatically adjusted external static pressure ensures correct airflow.

## ■ Cold climate heat pump

The heat pump with efficiently function down to 5°F outdoors.

## ■ 1,800 Watt electric heat

The electric heat works in conjunction with the heat pump when the heat pump has insufficient power.

## ■ Intelligent defrosting

AIO's intelligent defrosting system means more time heating and less time on reverse cycle defrost.

## ■ Coil cooling system

The condensate mister system drizzles the condensate on the outdoor heat exchanger coils, lowering the coil's temperature and increasing efficiency and performance.

## ■ Quiet

With whisper-quiet operation as low as 27 decibels, the occupant will barely notice AIO is operating.

## ■ No outside noise infiltration

AIO has the lowest STC and OITC rating among comparable units. This means less outside noise intruding into the room day and night.

## ■ Versatile on/off options

AIO's low voltage connection enables connection to any occupancy system, key-card, window sensors, fire alarms, etc.; as long as it can send a signal to AIO via low voltage, the unit can be easily turned on or off.

## ■ Corrosion protection

AIO comes standard with corrosion protection, assuring many years of trouble-free performance.

## ■ Minimal clearances and compact footprint

AIO's compact form with no line sets means there is no need to access the sides of the unit. Mount units with as little as 3/4 inch clearance on all sides. Compact footprints take up minimum space.

## ■ Leak protection

A drain alarm will activate if the drain becomes clogged, and the system will be shut off, preventing water damage.

## ■ Easy to service

AIO can be easily maintained and repaired from the front or bottom of the unit without having to remove the unit from the wall or ceiling. AIO can also be quickly swapped out with a replacement, reducing downtime.

## ■ Versatile controls

AIO includes an iOS and android app and an onboard touch controller. AIO can be used with optional wall-mounted controllers, including a TFT with 7 day program and third-party controllers from any company using the optional 3rd party kit. An optional BACnet and Modbus module enables interfacing with building management systems

## ■ 10-Year limited warranty

■ An industry-leading ten-year limited on-site warranty provides peace of mind. One full-year parts and labor. Nine-year parts and a full ten-year parts and labor on the sealed system, including the compressor.

# Technical requirements

## AIO Ceiling ducted specifications

Note: Refer to the full specifications for detailed information about the list of specifications.

- The power supply circuit is installed in accordance with the current edition of NEC (ANSI/NFPA 70) and local codes and ordinances. Note: Always consult local and national electric codes.
- Voltage rating of 60 Hz, 208V/230V single phase.
- Properly installed insulated condensate drain line with a minimum of 30% slope if an external drain. An internal drain is highly recommended.
- Approved louvers installed with best practices to ensure no water into the wall assembly.
- Correctly sized ductwork, installed properly and balanced.
- The unit must be perfectly level on the vertical and horizontal axis.
- Interior clearances are only required to prevent vibrations. Leave at least 1/3" of clearance from any surface. All others clearances are only dependent on ducting.
- The unit must be tight to ducts, with zero leakage between the external ducts and the unit.
- Properly affixed ceiling bracket to studs or other supporting material.
- Unblocked vents on the exterior and no obstacles within 36".
- An access panel with adequate clearance to be able to access the entire bottom of the unit for servicing.

## Louver specifications

AIO Ceiling Ducted units can be vented through all kinds of custom and creative solutions. The possibilities are endless, from perforated panels to custom louvers.

There are two critical factors in selecting and sizing a solution that will work with AIO Ceiling ducted units.

- **Free area:** This area on a louver/grille is open for the air to flow through. The louver, perforated panel, or other solution must have at least the amount of free area as required in the specifications below in the plenum from the unit so that ample air can enter and exit the condenser chamber. A more restrictive solution with a smaller free area can be utilized by enlarging the louver and plenum until the required free area is achieved.

**The minimum free area required is .34 sq feet for the intake vent and .34 sq feet for the exhaust vent.**

- **Pressure drop:** Pressure drop is the resistance the louver/grille creates against the airflow. This resistance can create heat build-up inside the condenser portion, causing the compressor to overheat and shut down. A solution with a higher pressure drop than specified can be utilized by enlarging the louver and plenum until the pressure drop is within specification.

**The maximum total pressure for the intake and exhaust ducting (if any) and intake and exhaust louvers combined must be under 0.7 WC.**

**To be clear, the entire assembly of ductwork, plenums, and louvers for the complete air circuit, in and out of the system may not exceed 0.7 WC.**

Any louver or louver assembly must meet these requirements, as exceeding these limits can cause the unit to overheat and fail and void the warranty.

The following louvers are approved for AIO Ceiling ducted units:

- Sunvent: LLA/C, LLA/M, LLA/S - available through your Ephoca distributor.
- Therma duct: RLA8- available through your Ephoca distributor.

# What's inside

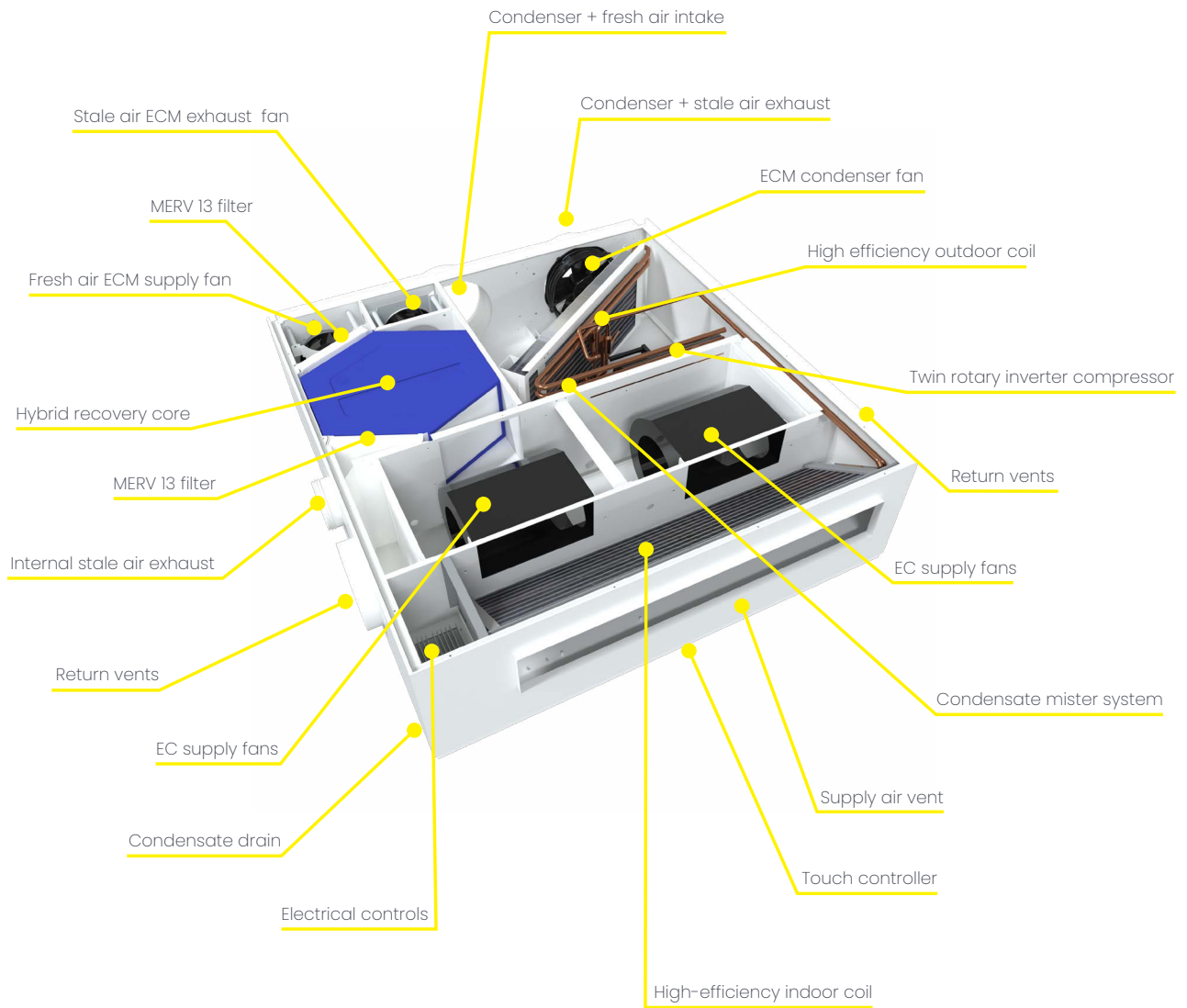

# Technical specifications

## Cooling

Indoor: 80°F, W.B. 67°F; Outdoor: 95°F, W.B. 75°F

		40 CFM	60 CFM	80 CFM
<b>Heat Pump</b>				
Range	Btu/h	3,400 - 14,000		
Nominal		8,300		
Input Power	W	722		
Efficiency	EER	11.50		
	SEER	14.60		

<b>ERV</b>				
Sensible recovery	Btu/h	600	890	1,140
Latent recovery		390	570	730
Input Power	W	18	34	53
Efficiency	EER	19.54	15.34	12.61

<b>Combined Heat Pump + ERV'</b>				
Range	Btu/h	5,190 - 15,990	5,660 - 16,460	6,070 - 16,870
Nominal		9,290	9,760	10,170
Input Power	W	740	756	775
Efficiency	EER	12.55	12.91	13.12
Moisture Removal	Pts/h	1.9		

## Heating 47°

Indoor: 70°F, W.B. 60°F; Outdoor: 47°F, W.B. 43°F

		40 CFM	60 CFM	80 CFM
<b>Heat pump</b>				
Range	Btu/h	4,200 - 15,000 + 6,100 Electric heat		
Nominal		8,200 + 6,100 Electric heat		
Input power	W	705		
Efficiency	COP	3.41		

<b>ERV</b>				
Recovery	Btu/h	1,230	2,000	2,490
Input power	W	18	34	53
Efficiency	COP	20.03	17.24	13.77

<b>Combined heat pump + ERV'</b>				
Range	Btu/h	5,430 - 16,230	6,200 - 17,000	6,690 - 17,490
		+ 6,100 Electric heat		
Nominal		9,400	10,200	10,700
		+ 6,100 Electric heat		
Input power	W	723	739	758
Efficiency	COP	3.81	4.05	4.14

## Heating 13°F

Indoor: 70°F, W.B. 60°F; Outdoor: 13°F, W.B. 9°F

		40 CFM	60 CFM	80 CFM
<b>Heat pump</b>				
Range	Btu/h	3,200 - 7,000 + 6,100 Electric heat		
Nominal		6,800 + 6,100 Electric heat		
Input power	W	906		
Efficiency	COP	2.04		

<b>ERV</b>				
Recovery	Btu/h	2,590	4,060	5,250
Input power	W	18	34	53
Efficiency	COP	42.17	35.00	29.03

## Heating 13°F (continued)

Indoor: 70°F, W.B. 60°F; Outdoor: 13°F, W.B. 9°F

		40 CFM	60 CFM	80 CFM
<b>Combined heat pump + ERV'</b>				
Range	Btu/h	5,660 - 9,460	7,260 - 11,060	8,450 - 12,250
		+ 6,100 Electric heat		
Nominal		8,760	10,360	11,550
		+ 6,100 Electric heat		
Input power	W	924	989	1,008
Efficiency	COP	3.73	4.12	4.51

## Heating 5°F

Indoor: 70°F, W.B. 60°F; Outdoor: 5°F, W.B. 3°F

		40 CFM	60 CFM	80 CFM
<b>Heat pump</b>				
Range	Btu/h	2,700 - 6,700 + 6,100 Electric heat		
Nominal		5,700 + 6,100 Electric heat		
Input power	W	945		
Efficiency	COP	1.77		

<b>ERV</b>				
Recovery	Btu/h	2,970	4,500	5,970
Input power	W	18	34	53
Efficiency	COP	48.36	38.79	33.01

<b>Combined heat pump + ERV'</b>				
Range	Btu/h	5,670 - 9,670	7,200 - 11,200	8,670 - 12,670
		+ 6,100 Electric heat		
Nominal		8,670	10,200	11,670
		+ 6,100 Electric heat		
Input power	W	963	979	998
Efficiency	COP	2.64	3.05	3.43

## ERV

<b>General</b>	
Flow type	Counterflow enthalpy exchanger
Material	Mold and bacteria resistant, washable polymer membrane
ASHRAE compliance	62.1 And 62.2 When used with the ERV module

		40 CFM	60 CFM	80 CFM
<b>Efficiency of core in winter</b>				
Sensible	%	86.7	85.2	83.1
Latent		72.5	65.1	60.3

<b>Efficiency of core in summer</b>				
Sensible	%	71.1	69.4	68.1
Latent		56.2	54.5	51.2

<b>Filter</b>				
Indoor air	MERV	MERV 3 / optional MERV 13		
Outside air		MERV 13		

<b>Leakage</b>				
Internal	WC	2.6% at 0.40"	2.4% at 0.40"	2.2% at 0.40"
External		2.8% at 1.0"	2.7% at 1.0"	2.5% at 1.0"

To understand the ratings, please see the section "Understanding the ratings" on the following pages.

# Technical specifications

## Airflow

Fresh air volume		
Indoor	Type	ECM centrifugal
	CFM	226 - 400
	Available ESP	0.6"
	Supply connection	3.9" H x 29.1" W
	Return connection	2 side 6" round or bottom 8.7" x 22.1"
	Speeds	Low, med, high, auto
Fresh air intake	Filter	MERV 3
	Type	ECM centrifugal
	CFM	20 - 85
	Speeds	Based on CFM
Stale air exhaust	Filter	MERV 13
	Type	ECM centrifugal
	CFM	20 - 85
	Available ESP	0.5"
	Connection	5" round
Outdoor	Speeds	Based on CFM
	Filter	MERV 13
	Type	ECM centrifugal
	CFM	385 - 638
	Available ESP	0.7"
	Intake connection	8" round
	Exhaust connection	
	Speeds	Low, med, high, auto

## Electrical

230V		
General		
Volt range		207 - 251
Hz/ phase		60 Hz single phase
Power supply		Hardwire
Power factor	%	0.96
Cooling (nominal)		3.3
Cooling (max)		7.8
Heating - heat pump only (nominal)	A	3.2
Heating -heat pump + electric (max)		16.1
Input power (standby)		10.8
Input power (off mode)	W	1.7
Motors		
Compressor	RLA	2.8
	LRA	4.7
	W (max)	180
	F.L.A.	0.8
Indoor ECM fan motor	HP	0.24
	W (max)	41
	F.L.A.	0.3
	HP	0.05
Fresh air intake ECM fan motor	W (max)	41
	F.L.A.	0.2
	HP	0.05
	W (max)	41
Stale air exhaust ECM fan motor	F.L.A.	0.2
	HP	0.05
	W (max)	190
	F.L.A.	0.8
Outdoor ECM fan motor	HP	0.25

## Circuit Breakers

Circuit breakers		
MCA - heat pump only		18
Recommended breaker size	A	20
MOCP		25

## Compressor

230V		
Model voltage		
Type		BLDC twin rotary inverter
Refrigerant	Type	R410a
	Oz.	21.87
Oil	Type	Fv50s

## Sound

General		
Indoor	dB(A)	27 - 43
	STC	40
	OITC	35
Outdoor	dB(A)	28 - 55

## General

Controls	
Basic functionality	Dependent on controller
WiFi	Optional module available
ADA compliant	Dependent on controller
Dry contact	Yes
Power outage restart	Auto-on based on last setting

Modes	
Operation	Cool+ fresh air, cool only, heat+ fresh air, heat only, auto
Restricted modes	Heat only, cool only, temperature limiting
Timers	Dependent on controller

Condensate	
Pipe size	3/4"

Physical data		
Dimensions	Net	38.3" W x 41.7" D x 11.3" H
	Gross	48" L x 48" W x 18" H
Weight	Net	170 Lb
	Gross	190 Lb
Cabinet	Finish	RAL 9003 signal white
	Material	Steel

Certification	
Safety	Field certified Intertek until full certification is complete
Energy efficiency	Innova Labs

Warranty	
Year 1	On-site parts and labor
Year 2 - 10	Parts only
	On-site parts and labor on compressor

# Airflow

AIO Ceiling Ducted is flexible in many ways. It can be fully ducted or used with minimal or no ducting. This flexibility enables AIO Ceiling Ducted to be placed anywhere in a dwelling without restrictions.

## ■ Supply air

The rectangular 4" x 29" supply air connection is ideal for a supply grille or ducting, with up to 0.6" external static pressure (combined between return and supply).

## ■ Stale air exhaust

The five-inch round stale air exhaust connection can be used as part of a plenum return without any ducting or can be ducted to a bathroom or multiple locations with up to 0.5" external static pressure. If configuring AIO Ceiling Ducted with a bottom return, the stale air can also be pulled from the bottom return.

## ■ Return air - bottom option

The bottom 8.7" x 22" return is designed to be used with a ceiling-mounted return grille or an access panel with an integrated return grille.

## ■ Return air - sides options

The left and right side 6" round connection can be ducted to one or more rooms with up to 0.6" external static pressure (combined between return and supply). It can also be left open as a side plenum return. With two ECM fans, each with auto ESP, each connection is fully independent. Duct both, leave both open or duct one, and leave one open to a plenum.

## ■ Outside air intake

The single 8" round outside air intake connection provides air for the condenser portion and fresh air for the inside. This can be ducted with up to 0.7" external static pressure (combined between intake and exhaust).

## ■ Outside air exhaust

The single 8" round outside air exhaust connection is for the condenser portion and the stale air exhaust. This can be ducted with up to 0.7" external static pressure (combined between intake and exhaust).

## Bottom return

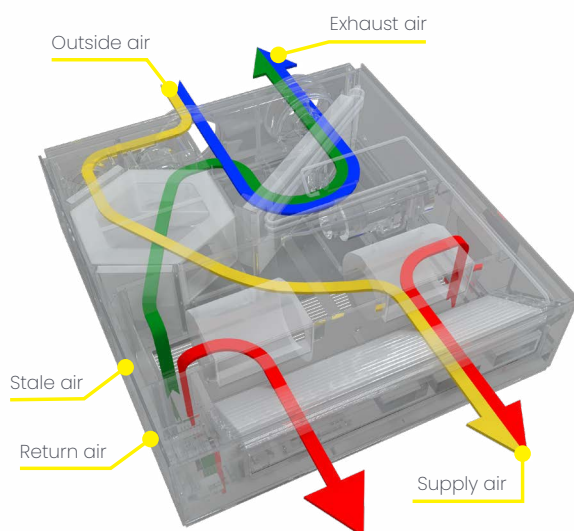

## Side return

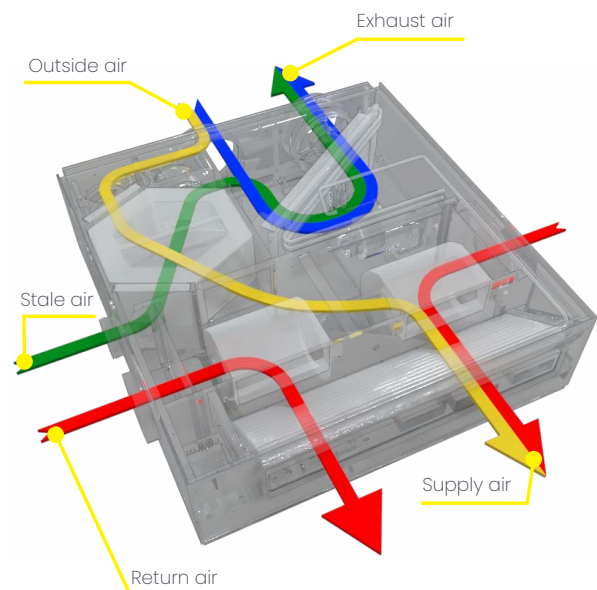

■ Outside air   ■ Recirculate air   ■ Fresh air intake   ■ Stale air exhaust



# Understanding the ratings

AIO is a unique system that incorporates a heat pump and ERV in a single package. To understand the specifications, you must read this first to understand. There are different ways to bring treated outside air into a dwelling unit; using a rooftop package, PTAC or VTAC, DOAS, ERV, or a fresh air intake kit.

## ■ Package systems such as Rooftop, PTAC, and VTAC

In these systems, outside air is introduced via a vent and heated/cooled using the heat pump or electric heat (if the outside temperature is below the heat pump's operating range). The heat pump's capacity must include inside and outside air loads.

## ■ DOAS (Dedicated Outside Air Systems)

DOAS units condition the outside air to inside temperature with a heat pump. With a DOAS, the only load is the outside air.

## ■ ERV Systems

ERV systems utilize the heat/cold from the exhausted stale air to heat/cool the incoming outside air. As ERVs are only 60% and 85% efficient, the outside air must be further heated/cooled to meet room temperature. Depending on the system design, the air can be passed through an additional dedicated heat pump or passed into the return of a fan coil unit. Regardless, the heat pump's capacity must be calculated to cover the load which the ERV does not recover.

## ■ Fresh air intake kit for indoor units

Some indoor units (such as cassettes and ducted) of VRF and other split systems will accommodate a fresh air kit, where outside air is ducted into the return of the indoor units. The indoor fan coil and connected outdoor heat pump must accommodate inside and outside air loads.

## How AIO works

AIO integrates an ERV with the heat pump providing an all-in-one solution with maximum efficiency. Outside air is initially treated by the super-efficient ERV core, recovering up to 86% of the sensible heat from the exhaust air, and the heat pump treats the remainder before it enters the supply air. To further boost efficiency, the heat remaining after passing through the recovery core is used to slightly warm/cool the outdoor heat exchanger, lowering/raising the coil's temperature.

With AIO, just like any other solution with an ERV, a percentage of the heat pump's capacity is used to heat the outside air and must be factored into the load calculation. AIO is available with or without the ERV option; if AIO is used only as a heat pump, all the heat pump's capacity can be utilized for the room's load.

## Explanation of the terms

Below is a list of terms used in the specifications and their explanation.

### Heat Pump

#### ■ Range

AIO's twin rotary inverter compressor enables a wide range of capacities. The capacity range reflects the minimum and maximum capacity of the heat pump. Using AIO in an environment that requires less than the minimum will result in AIO's inverter compressor operating as an on-off compressor. While this will not damage AIO or shorten the lifespan, it will reduce efficiency. It is important to note that a small percentage of the capacity will be utilized to heat/cool the outside air.

While the capacity range is wide, Ephoca does not recommend using AIO in an environment that consistently requires more than 10,500 BTU. Beyond that limit, AIO is louder and less efficient. The additional capacity is helpful for those occasions when extra capacity is needed.

#### ■ Nominal

This is rated capacity, used for efficiency testing purposes. With an inverter-based heat pump, a manufacturer can "lock" the inverter compressor to a specific frequency to control the capacity for a test. This capacity was selected as it achieves the optimum efficiency to capacity ratio. A lower capacity will achieve a more efficient rating but will be officially too small, and a larger capacity will have a less efficient rating with inverter compressors; the lower the frequency (capacity), the better the efficiency. This is what makes inverters so efficient, as most of the time, an inverter will operate at less than half the capacity. This number rating is only provided for official rating purposes and for comparing with similar units in apples-to-apples comparisons.

#### ■ Input power

This is the input power to operate AIO at the rated capacity and does not include the input power of the ERV fans. Using AIO in an environment that requires less capacity than the rated will result in less power input, and a higher capacity will use more input power.

#### ■ Efficiency

This is the official efficiency of AIO based on AHRI testing standards based on the rated capacity. Using AIO in an environment that requires less than the rated will result in a higher efficiency rating. An environment with higher loads will have a lower efficiency rating. This number is only provided for official rating purposes and to compare with similar units in apples-to-apples comparisons.

# Understanding the ratings

## ERV

### ■ Capacity

This is the capacity of the ERV based on CFM of outside air. The higher the CFM, the higher the capacity. It is critical to note that the ERV's capacity can only be used to offset the load required to heat/cool the outside air, which will always be greater than the capacity of the ERV. This capacity never be used to heat/cool the inside air.

### ■ Input power

This is the input power of two ERV fans. One pulls outside air through the ERV core; the other pulls the stale air through the ERV core. The higher the CFM of outside air, the higher the input power. The CFM of outside air is fully controllable and can be set anywhere from 20 to 85 CFM. The speed of the ECM fans controls this.

### ■ Efficiency

The effective efficiency of the ERV is exceptionally high, as the only input power is the ECM fan. The efficiency is dependent upon the CFM and related fan power.

### ■ Nominal

This capacity range is useful as a quick reference to see if AIO will be able to support the combined load of indoor and outside air. This combined capacity can not be used solely for inside air.

### ■ Input power

This is the input power to operate AIO at the rated capacity and the input power of the ERV fans. Using AIO in an environment that requires less capacity than the rated will result in less power input and a higher capacity will use more input power.

### ■ Efficiency

The effective efficiency of the heat pump and the ERV is higher than the efficiency of just the heat pump. However, this combined efficiency presents a more accurate picture of the efficiency of AIO as it shows the benefit of a combined ERV heat pump versus other types of configurations.

## Combined Heat Pump + ERV Section

### ■ Range

This reflects the combined capacity range of the heat pump (as described in the heat pump section) and the ERV (as described in the ERV section). This combined capacity range helps compare the capacity required using only a heat pump to heat/cool the outside and inside air instead of an ERV and a heat pump.

For example, a 12x15 room requires 8,000 BTU, and 35 CFM of outside air requires 3,000 BTU, requiring 11,000 BTU's.

There are two ways to achieve this:

- Typical, where all 11,000 BTU are from the heat pump/ electric heat.
- AIO, with 11,000 BTU of combined capacity. In this case, AIO's heat pump provides 8,000 BTUs for the room and 480 BTU (16% of the 3,000 BTU) for the outside air. The recovery on the ERV would provide the remaining 2,520 BTU required to heat/cool the outside air.

This capacity range is useful as a quick reference to see if AIO will be able to support the combined load of indoor and outside air. This combined capacity can not be used solely for inside air.

# AIO Ceiling Ducted ADK10R4H2 Submittal

Products are subject to continuous improvements and Ephoca reserves the right to modify product design, and specifications without notice.

Job	Reference	Construction
Location	Approval	Quote Number
Engineer	Date	Drawing Number
Submitted To	Submitted By:	P.O. Number:

## ERV performance

General	
Flow type	Counterflow enthalpy exchanger
Material	Mold and bacteria resistant, washable polymer membrane
ASHRAE compliance	62.1 And 62.2 When used with the ERV module

	40 CFM	80 CFM	80 CFM
<b>Efficiency of core in winter</b>			
Sensible %	86.7	85.2	83.1
Latent	72.5	65.1	60.3

<b>Efficiency of core in summer</b>			
Sensible %	71.1	69.4	68.1
Latent	56.2	54.5	51.2

Filter	
Indoor air	MERV 3 / optional MERV 13
Outside air	MERV 13

Leakage			
Internal	WC	2.6% at 0.40"	2.4% at 0.40"
External		2.8% at 1.0"	2.7% at 1.0"

## Heat pump performance

Cooling			
Moisture Removal	Pts/h	1.9	
Range	Btu/h	3,400 - 14,000	
Cooling Capacity	Btu/h	8,300	
Indoor: 80°F, W.B. 67°F; Outdoor: 95°F, W.B. 75°F	Input Power	W	722
	Efficiency	EER	11.50
		SEER	14.60

Heating			
Sensible Heat Factor	%	86	
Heating 47°F	Range	Btu/h	4,200 - 15,000 +6,100 electric heat
Indoor: 70°F, W.B. 60°F; Outdoor: 47°F, W.B. 43°F	Capacity	Btu/h	8,200 +6,100 electric heat
	Input Power	W	705
	Efficiency	COP	3.41
Heating 13°F	Range	Btu/h	3,200 - 7,300 +6,100 electric heat
Indoor: 70°F, W.B. 60°F; Outdoor: 13°F, W.B. 9°F	Capacity	Btu/h	6,300 +6,100 electric heat
	Input Power	W	906
	Efficiency	COP	2.04
Heating 5°F	Range	Btu/h	2,700 - 6,700 +6,100 electric heat
Indoor: 70°F, W.B. 60°F; Outdoor: 5°F, W.B. 3°F	Capacity	Btu/h	5,700 +6,100 electric heat
	Input Power	W	945
	Efficiency	COP	1.77

## Compressor

General	
Type	BLDC twin rotary inverter
Refrigerant	Type R410a

## Airflow

General		Indoor	Fresh air	Outdoor
Fan	Motor	ECM		
	Type	Centrifugal	Centrifugal	Centrifugal
Input power	W	180	41	190
Airflow	CFM	226 - 400	25 - 85	385 - 638
ESP	WC	0.6"	0.5"	.07"
Speeds		Low, med, high, auto	Auto	Low, med, high, auto

## Sound

General		
Indoor	dB(A)	27 - 43
	STC	40
	OITC	35
Outdoor	dB(A)	28 - 55

## Electrical

General	
Volt range	207 - 251
Hz/ phase	60 Hz single phase
Power Cord	Hardwire
Power factor	% 0.96
Cooling (nominal)	3.3
Cooling (max)	7.8
Heating (nominal)	A 3.2
Heating - heat pump + electric (max)	16.1
Circuit breakers	
MCA - heat pump only	18
Recommended breaker size	A 20
MOCP	25

## Warranty

Warranty	
Year 1	On-site parts and labor
Year 2 - 10	Parts only
	On-site parts and labor on compressor

## Dimensions

General	
Dimensions	Net 38.3" W x 41.7" D x 11.3" H
	Gross 48" L x 48" W x 18" H
Weight	Net 170 Lb
	Gross 190 Lb
Cabinet	Finish RAL 9003 signal white
	Material Steel

# Dimensions

## Dimensions

For CAD and DWG files, please scan or click the QR code below.

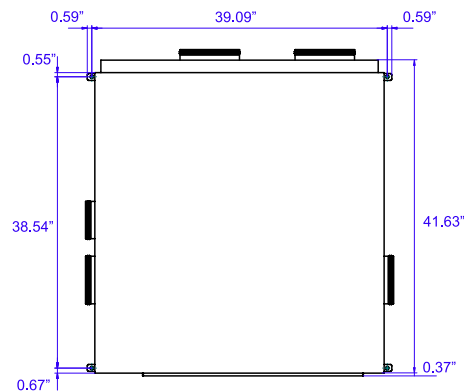
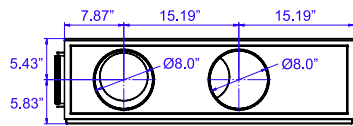
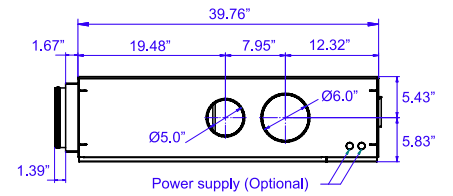
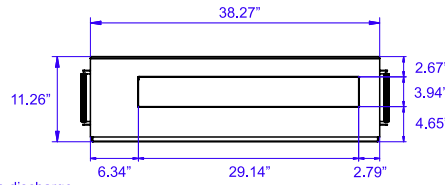
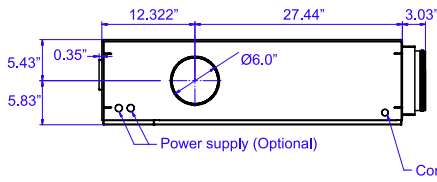
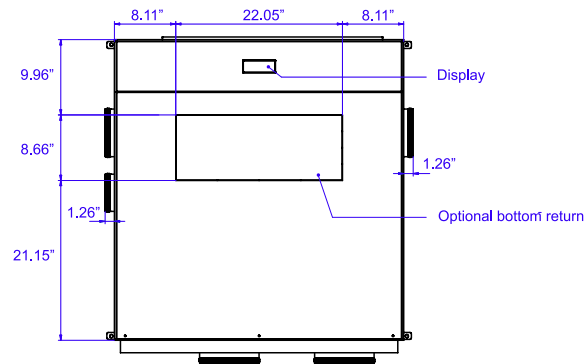

# Clearances

The AIO Ceiling Ducted unit's clearance will depend on how it is vented. Please carefully read the criteria below to determine the correct clearance required.

## ■ Ceiling

There must be  $1/3$ " minimum clearance between the unit and ceiling to minimize noise from vibrations.

## ■ Bottom

There must be a minimum of  $1/3$ " clearance between the unit and the false ceiling or access panel to minimize noise from vibrations.

## ■ Front

The clearance required in front of the unit to drywall or other material is  $1/3$ " to minimize noise from vibrations.

## ■ Rear

There must be  $1/3$ " minimum clearance between the unit and wall to minimize noise from vibrations. Ensure sufficient clearance to attach ductwork to the rear vents.

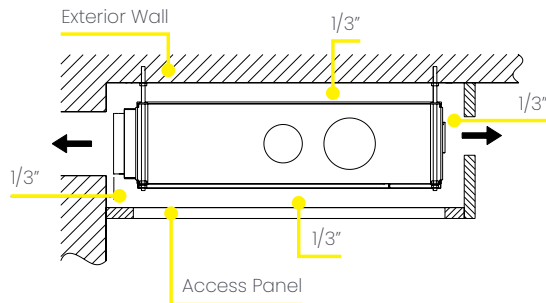

## ■ Access Panel

There must be an access panel of at least the size of the unit plus  $1/2$  inch all around. The recommended size is 39.5 x 41. The minimum size is 39 x 40.5. You can use a return grill as an access panel or an access panel with an integrated return grille.

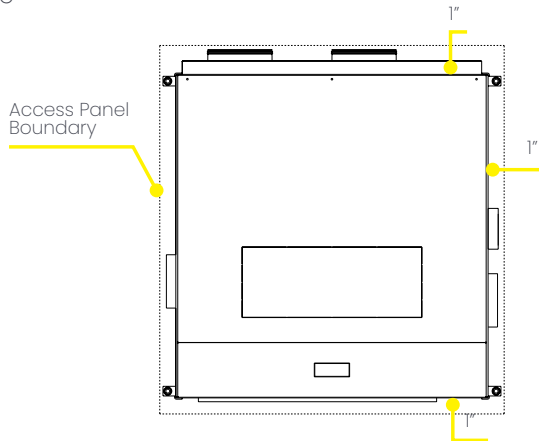

## ■ Sides

The clearance required on the sides is dependent on how the unit is configured for return and stale exhaust air. Minimum clearance between the unit and wall to minimize noise from vibrations. Ensure sufficient clearance to attach ductwork to the rear vents.

## ■ Bottom return configuration:

The only clearance required on the sides is 1.5". This is only necessary for the mounting brackets and to eliminate noise from vibrations. Larger clearance will make it easier to mount and service the unit.

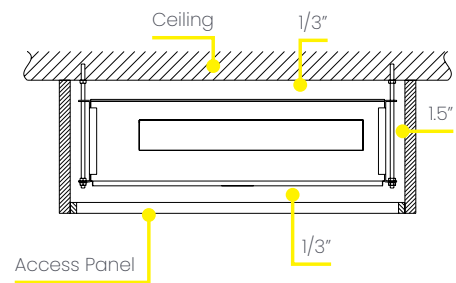

## ■ Side ducted return configuration

The clearance required is based solely on ductwork design. Ensure sufficient clearance to attach the ductwork to the side return.

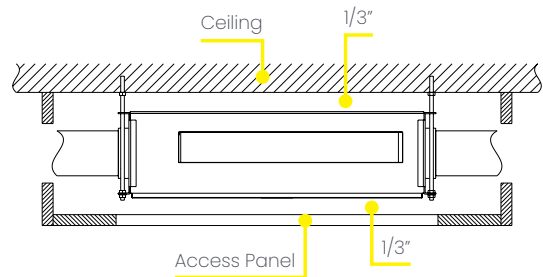

## ■ Side plenum return configuration

A minimum of 3.5" should be free for airflow on each side to allow the air to flow into the returns.

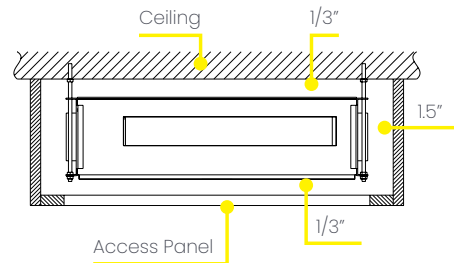

## ■ Exterior

On the exterior of the building, there should be no obstacles blocking the airflow from the louver. There must be at least 40" of free and clear space in front of the louvers.

# Wiring Diagram

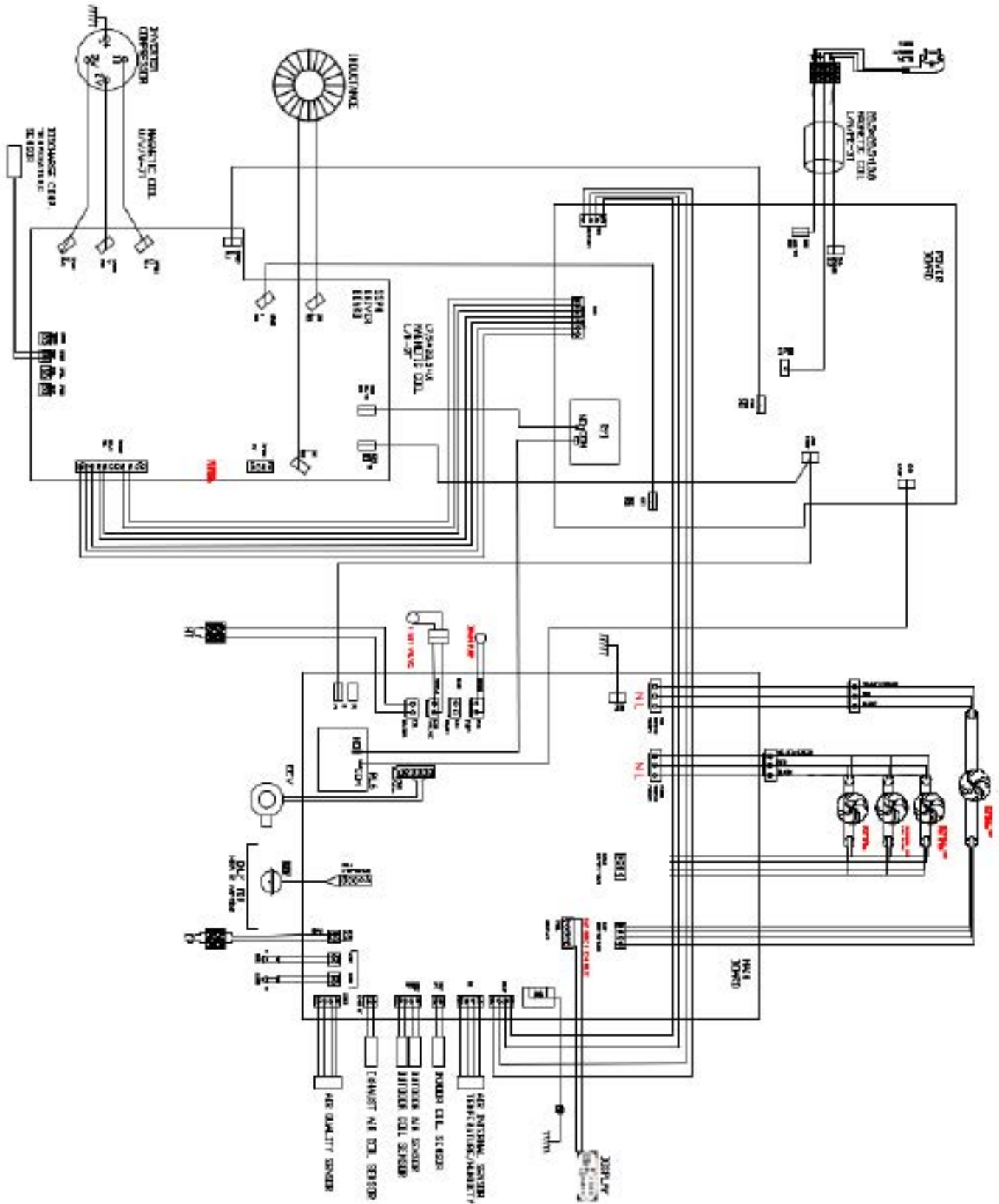



With over 15 years of experience in the climate comfort sector, we have a clear goal: growth through innovation. Our team is laser-focused on the conception, development, and production of innovative heating, ventilation, and air conditioning solutions. This mission has developed through bringing together technical skills, creativity, technology, design, Italian passion, and a global vision to achieve the best energy efficiency and performance.

Ephoca is the US subsidiary of Innova SRL - Via 1° Maggio, 8 - 38089 Storo (TN) Italy.

**ephoca.com** | 216-710-1000



**MADE IN ITALY**