

CERTIFICATE

Certified Passive House Component

Component-ID 1107wc03 valid until 31st December 2023

Passive House Institute
Dr. Wolfgang Feist
64283 Darmstadt
Germany

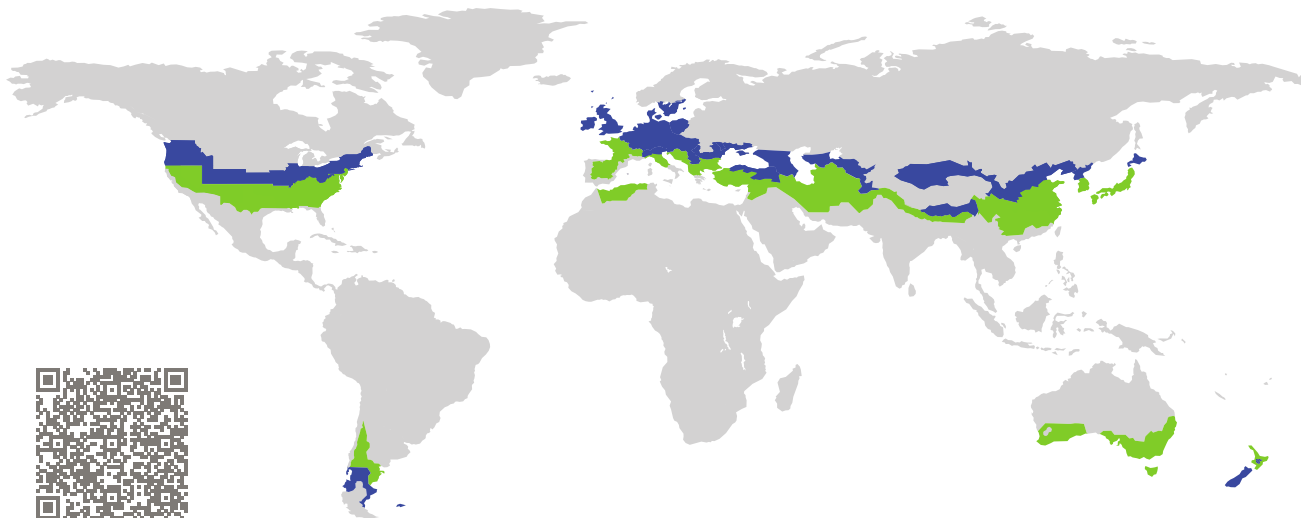

Category: **Window connection**
Manufacturer: **Meesenburg Großhandel KG,
Flensburg,
Germany**
Product name: **blaugelb Triotherm+ System**

**This certificate was awarded based on the following
criteria for the cool, temperate climate zone**

Comfort $U_{W,installed} \leq 0.85 \text{ W}/(\text{m}^2 \cdot \text{K})$
with $U_g = 0.70 \text{ W}/(\text{m}^2 \cdot \text{K})$

Hygiene $f_{Rsi=0.25} \geq 0.70$

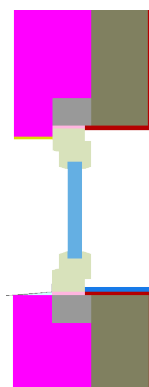

Passive House
efficiency class

phE

phD

phC

phB

phA

cool, temperate climate



**CERTIFIED
COMPONENT**

Passive House Institute

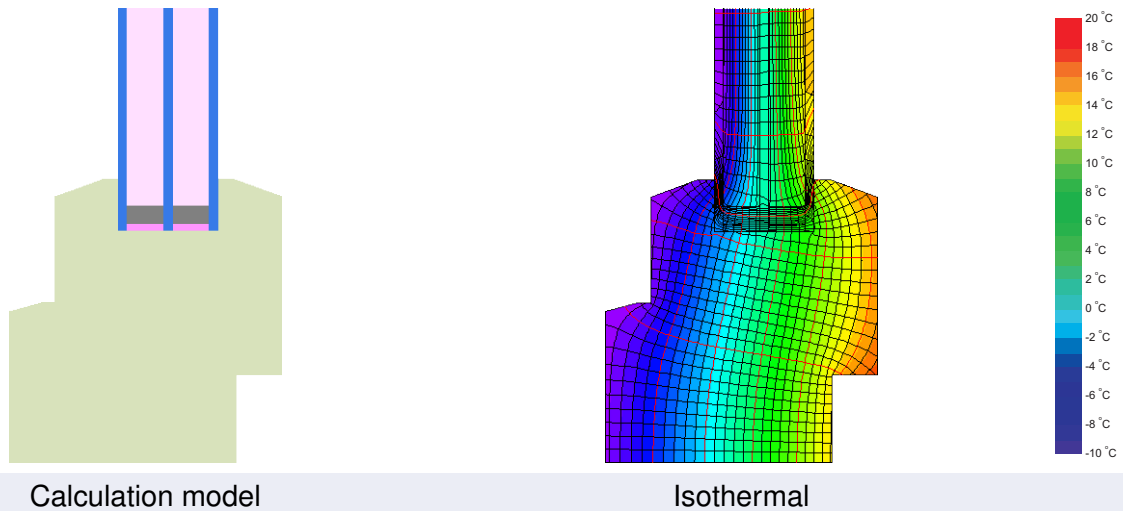

Description

Window Mounting System from dense EPS foam (0,041 W/(mK)), system width 120 mm. Assembly by glueing and screwing. Additional thermal losses by screws determined by 3D heat flux simulation. Losses are included in the conductivity of the EPS-foam.

Explanation

The window U-values were calculated for the test window size of 1.23 m × 1.48 m with $U_g = 0.70 \text{ W}/(\text{m}^2 \cdot \text{K})$. If a higher quality glazing is used, the window U-values will improve as follows:

Glazing	$U_g =$	0.70	0.65	0.60	0.55	$\text{W}/(\text{m}^2 \cdot \text{K})$
		↓	↓	↓	↓	
Window	$U_W =$	0.80	0.76	0.73	0.70	$\text{W}/(\text{m}^2 \cdot \text{K})$



Transparent building components are classified into efficiency classes depending on the heat losses through the opaque part. The frame U-Values, frame widths, thermal bridges at the glazing edge, and the glazing edge lengths are included in these heat losses. A more detailed report of the calculations performed in the context of certification is available from the manufacturer.

The Passive House Institute has defined international component criteria for seven climate zones. In principle, components which have been certified for climate zones with higher requirements may also be used in climates with less stringent requirements. In a particular climate zone it may make sense to use a component of a higher thermal quality which has been certified for a climate zone with more stringent requirements.

Further information relating to certification can be found on www.passivehouse.com and passipedia.org.

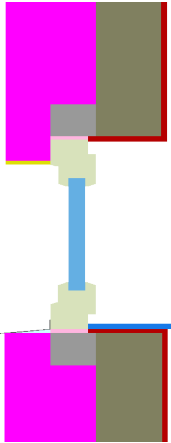
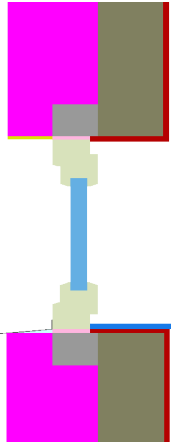
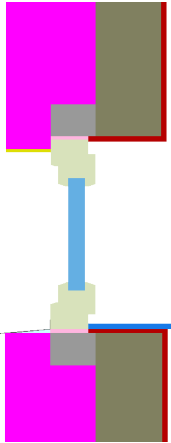
Validated installations

Mounting System Timber/PVC completely covered by insul		Mounting System Timber/PVC not covered by insulation		Mounting System Timber/PVC partially covered by insul	
$U_{Wall} = 0.13 \text{ W}/(\text{m}^2 \cdot \text{K})$		$U_{Wall} = 0.13 \text{ W}/(\text{m}^2 \cdot \text{K})$		$U_{Wall} = 0.13 \text{ W}/(\text{m}^2 \cdot \text{K})$	
					
$\Psi_{install}$	W/(m · K)	$\Psi_{install}$	W/(m · K)	$\Psi_{install}$	W/(m · K)
Top	0.002	Top	0.018	Top	0.011
Side	0.002	Side	0.018	Side	0.011
Bottom	0.018	Bottom	0.018	Bottom	0.018
$U_{W,installed} = 0.81 \text{ W}/(\text{m}^2 \cdot \text{K})$		$U_{W,installed} = 0.85 \text{ W}/(\text{m}^2 \cdot \text{K})$		$U_{W,installed} = 0.84 \text{ W}/(\text{m}^2 \cdot \text{K})$	

Frame values		Frame width b_f mm	U-value frame U_f W/(m ² · K)	Ψ -glazing edge Ψ_g W/(m · K)	Temp. Factor $f_{Rsi=0.25}$ [-]
Bottom	(OB1) 	125	0.73	0.036	0.70
Top	(OH1) 	125	0.73	0.036	0.70
Lateral	(OJ1) 	125	0.73	0.036	0.70
Spacer: PHI pHB-Spacer			Secondary seal: Polysulfid		

